

EXP

STAIR NOSING PROFILES

WITH SPECIALS INSERTS, FOR TILES AND FLOORING SURFACES

DURAL

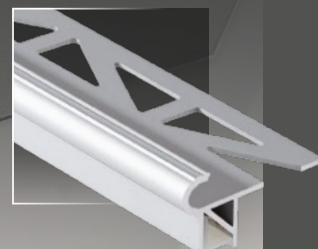
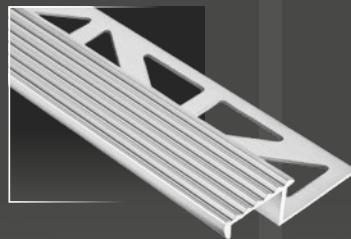
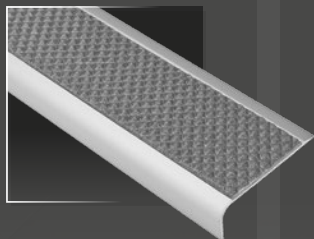

DIAMONDSTEP,
TREDSAFE,
DIAMONDTRD

FLORENTOSTEP-LED,
FLORENTOSTEP,
DURASTEP-WOOD
DURASTEP

PROTECT, STEP,
SOFT, TEKA, LINO,
STEPFLOOR / -G,
CLIPPER Step, REWI

STAIR NOSING PROFILES

Steps and stairs present a major challenge for any architect, designer or tradesman. They need to look good but must also be safe to walk on and easy to climb.

DURAL is now turning them into versatile room features, combining aesthetics and functionality in a safe and durable fashion, step by step.



Stair nosing profiles with safety inserts		3
DIAMONDTRED	Anti-slip safety insert	5
DIAMONDSTEP	Stair nosing profile with safety insert for tiled steps	6
TREDSAFE	Stair nosing profile with safety inserts for retrofitting	8

Stair nosing profiles for tiles		12
FLORENTOSTEP-LED	LED-illuminated stair nosing profile in aluminium with a florentine design for steps with tiled or natural stone surfaces in internal and external areas	13
FLORENTOSTEP	Highly decorative metal stair nosing profile in a florentine design for steps with tiled or natural stone surfaces in internal and external areas	14
DURASTEP-WOOD <i>Provence</i>	Stair nosing profile with a rounded visible edge solid wood tread for internal areas	16
DURASTEP-WOOD <i>Toscana</i>	Stair nosing profile with a rounded visible edge solid wood tread for internal areas	16
DURASTEP <i>Solid</i>	Metal stair nosing profile for steps in extremely high foot traffic areas	17
DURASTEP <i>Standard</i>	Stair nosing profile with a PVC insert for steps in medium foot traffic areas	17
DURASTEP <i>Jumbo</i>	Stair nosing profile with a PVC insert for steps in high foot traffic areas	17

Stair nosing profiles for flooring surfaces		18
PROTECT	Stair nosing profile for retrofitting, suitable for all surfaces	19
STEP	Stair nosing profile with a PVC insert for retrofitting	20
SOFT	Push-in stair nosing profile in PVC for extra-thin flooring surfaces	20
TEKA	Stair nosing profile in aluminium for the insertion of thin flooring surfaces	21
LINOLEUM	Stair nosing profile in aluminium for linoleum surfaces	21
STEPFLOOR	Push-in stair nosing profile with a rounded visible edge for parquet or laminate flooring	22
STEPFLOOR-G	Push-in stair nosing profile with a square visible edge for parquet or laminate flooring	22
CLIPPER <i>Step</i>	Stair nosing profile in aluminium without visible screws for flooring surfaces	23
REWI	Stair renovation profile for wooden or concrete steps	23

STAIR NOSING PROFILES

WITH SAFETY INSERTS



DIAMONDTRED	5
DIAMONDSTEP	6
TREDSAFE	8

DIAMONDTRED

The durable anti-slip safety insert



101 safety white



103 safety green



104 safety red



105 safety blue



118 signal yellow



106 neutral black



107 charcoal grey



108 light grey



109 rich brown



110 putty



111 royal blue



112 burgundy



113 mid grey



114 jade green



121 chevron signal yellow



116 night glow, 117 super night glow

The DIAMONDTRED safety insert is the heart of the DIAMONDTRED and TREDSAFE stair nosing profiles from DURAL. Its outstanding non-slip properties and signal colours (some luminescent) increase both step safety and visibility, thereby reducing the risk of an accident. The diamond structure reduces the aquaplaning effect to a minimum thanks to an increased displacement area. DIAMONDTRED safety inserts comply with slip resistance class R10 V6. DIAMONDTRED safety inserts are easy to install thanks to their powerful self-adhesive backing and can also be fitted without profiles.



- Excellent non-slip properties whether dry or wet
- Reduced aquaplaning effect
- Simply installation thanks to self-adhesive underside
- Retains shape even under tension

DIAMONDTRED

Material: PVC
Widths: 13, 37, 43, 53 mm
Lengths: 250 cm
Roll, 25 m



DIAMONDTRED inserts are available in a wide range of colours. Muted colours such as "mid grey" or "neutral black" fit harmoniously within the environment. In contrast, "signal yellow" or "safety red" provide a clear and visible warning of dangerous steps and edges. Or night glow/super night glow, luminescent colours that provide for much greater safety during dusk, or being plunged into darkness due to a power failure.

DIAMONDSTEP

Stair nosing profile with an anti-slip safety insert



With reliable anti-slip properties and ideal for high foot traffic areas, DIAMONDSTEP is a tried and tested solution for steps and stairways in both public and private areas. A wide choice of colours and an appealing design, DIAMONDSTEP enhances every single step with greater safety and an attractive appearance. The downward curving visible edge protects the step edges from mechanical stresses and conceals unattractive cut edges – also ideal for polished granite steps with up to 13.5 mm thick. The base profiles are made of high quality, silver anodised aluminium for internal areas, or stainless steel for weather-proofing in conditions such as rain, ice and snow.

- **Ideal for all tiled and natural stone steps and edges**
- **Extremely safe to walk withstands heavy foot traffic**
- **Ideal for barrier-free construction**
- **Replaceable inserts**
- **Covers unattractive edges**



**DIAMONDSTEP
with insert**

Material: Aluminium/PVC
Installation height: 11 mm
Lengths: 150, 250 cm
Insert width: 13 mm
Insert colours: neutral black,
charcoal grey, rich brown,
putty, mid grey

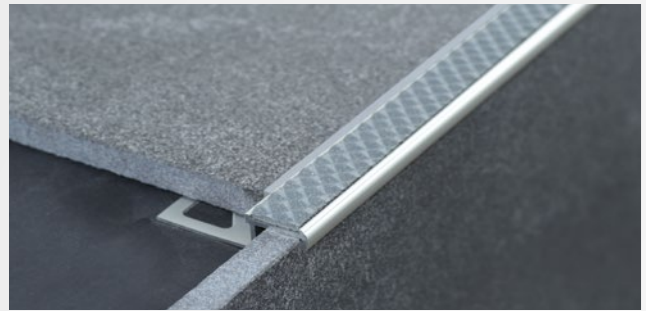
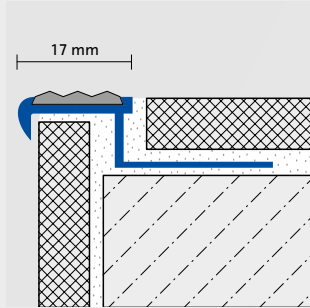

**DIAMONDSTEP
with insert**

Material: Stainless steel/PVC
Installation height: 11 mm
Lengths: 250 cm
Insert width: 13 mm
Insert colours: neutral black,
charcoal grey, rich brown,
putty, mid grey

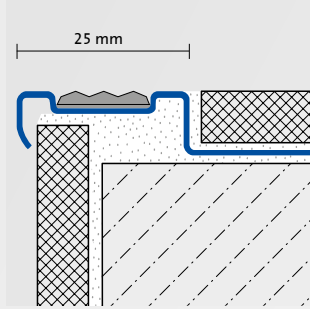

**DIAMONDSTEP
without insert**

Material: Stainless steel
Insert width: 13 mm
Installation heights:
4.5, 9, 11, 13.5 mm
Length: 250 cm

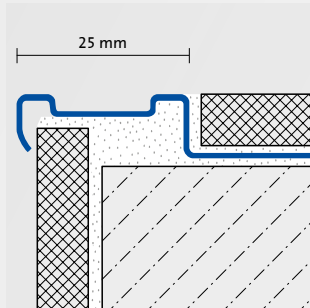

**DIAMONDSTEP
without insert**

Material: Aluminium
Insert widths:
13, 37, 3 x 13 mm
Installation heights:
4.5, 9, 11, 13.5 mm
Length: 250 cm

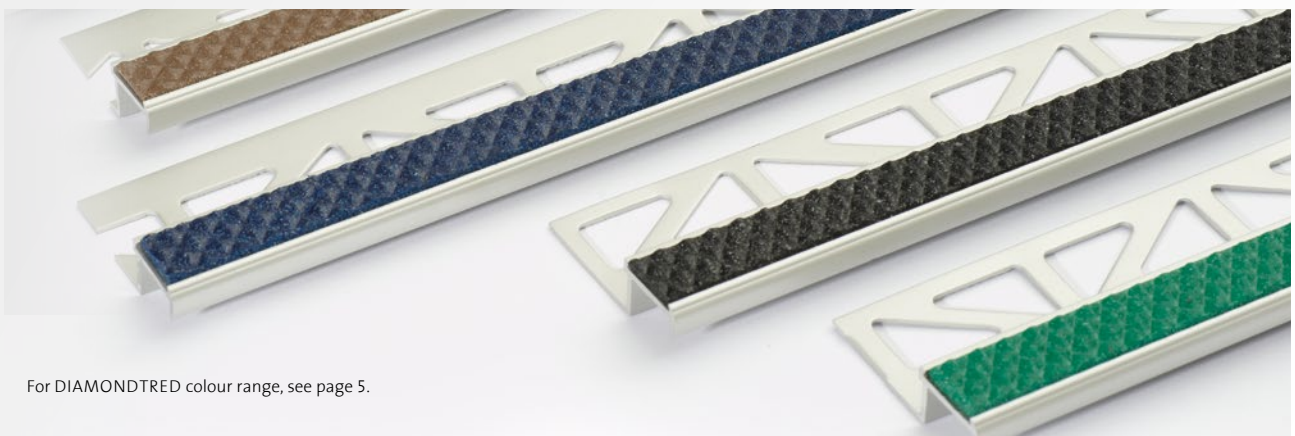
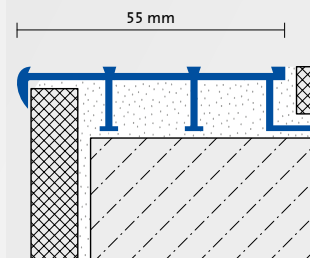
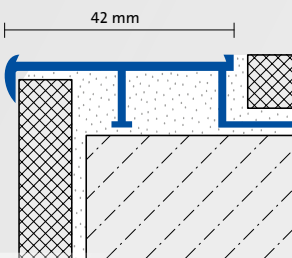
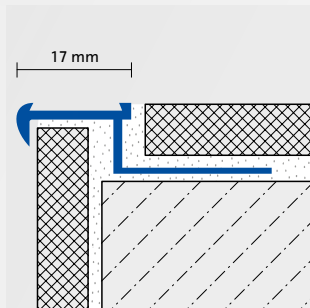

TREDSAFE

Stair nosing profile for anti-slip safety insert for retrofitting



The combination of TREDSAFE with DIAMONDTRED, the anti-slip insert, is a sophisticated stair nosing concept that turns steps and stairs into versatile room features, combining aesthetics and functionality in a safe and durable fashion. This creates a new and unique safety standard for steps and stairs. TREDSAFE is attractive not only due to its functionality, but also thanks to its design and appearance. The profiles are made of anodised aluminium, a special feature for this type of stair nosing profile. In addition to greater safety, this also offers a visual enhancement for steps and stairways. For special loading situations, e.g. in external areas, stainless steel variants are also available.

- **For retrofitting**
- **Extremely safe to walk on withstanding heavy foot traffic**
- **Ideal for open sided steps and stairs**



TREDSAFE Profiles

With a chamfered edges, for safe access and clearly visible marking of steps and landings.

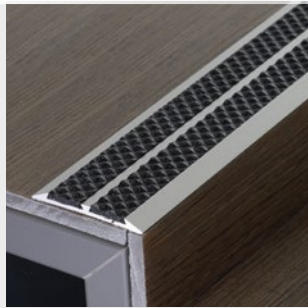

TREDSAFE TACTILE

for 1 x insert, 13 mm
Material: Aluminium, silver anodised
Visible width: 32 mm
Height: 3 mm
Lengths: 250, 300 cm



AA 132

TREDSAFE

for 1 x insert, 13 mm
Material: Aluminium, silver anodised
Visible width: 28 mm
Height: 4 mm
Lengths: 250, 300 cm

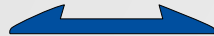

AA 140

TREDSAFE

for 2 x insert, 13 mm
Material: Aluminium, silver anodised
Visible width: 45 mm
Height: 4 mm
Lengths: 250, 300 cm



AA 231

TREDSAFE Profiles

With a chamfered rear edge and front profiling to reduce the risk of tripping, increase safety and protect the step edge, for direct installation on the flooring surface.

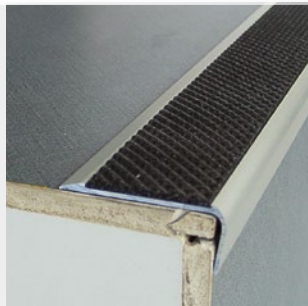

TREDSAFE

for 1 x insert, 43 mm
Material: Aluminium, silver anodised
Visible width: 58 mm
Heights: 24 mm (AA 122), 44 mm (AA 125)
Lengths: 250 cm

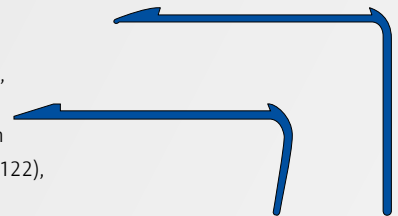

AA 122 AA 125

TREDSAFE

for 1 x insert, 13 mm
Material: Aluminium, silver anodised
Visible width: 28 mm
Height: 9 mm
Lengths: 250 cm

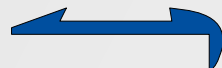

AA 139

TREDSAFE

for 2 x insert, 43 mm
Material: Aluminium, silver anodised
Visible width: 131 mm
Height: 36 mm
Lengths: 250 cm

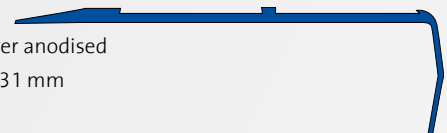

AA 207

TREDSAFE

for 2 x insert, 37 mm
Material: Aluminium, silver anodised
Visible width: 92 mm
Height: 24 mm
Lengths: 250 cm

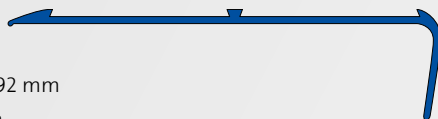

AA 210

TREDSAFE

for 2 x insert, 37 mm
Material: Aluminium, silver anodised
Visible width: 92 mm
Height: 44 mm
Lengths: 250 cm

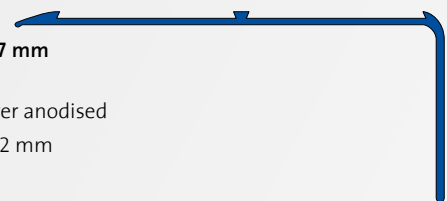

AA 211

TREDSAFE

for 2 x insert, 13 mm
Material: Aluminium, silver anodised
Visible width: 50 mm
Height: 24 mm
Lengths: 250 cm



AA 221

TREDSAFE

for 1 x insert, 37 mm
Material: Stainless steel (V2A)
Visible width: 54 mm
Height: 25 mm
Lengths: 250 cm

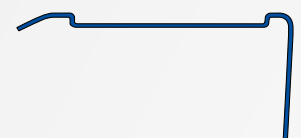

EE 122

TREDSAFE Profiles

with leading edge for clean surface transitions with the most diverse step edge designs, e.g. for linoleum or design flooring.

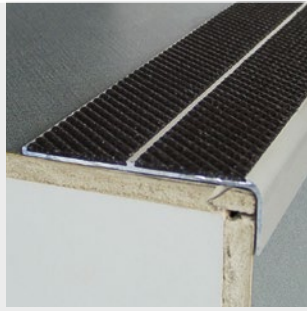

TREDSAFE

for 1 x insert, 43 mm

Material: Aluminium, silver anodised

Visible width: 51 mm

Heights: 26 mm (AA 109), 44 mm (AA 114)

Lengths: 250 cm

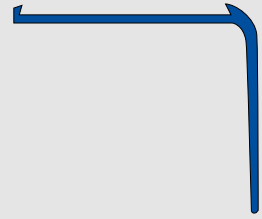

AA 109 / 114

TREDSAFE

for 1 x insert, 43 mm

Material: Aluminium, silver anodised

Visible width: 49 mm

Height: 38 mm

Lengths: 250 cm



AA 113

TREDSAFE

for 1 x insert, 43 mm

Material: Aluminium, silver anodised

Visible width: 57 mm

Height: 39 mm

Lengths: 250 cm



AA 115

TREDSAFE

for 2 x insert, 37 mm

Material: Aluminium, silver anodised

Visible width: 84 mm

Height: 44 mm

Lengths: 250 cm

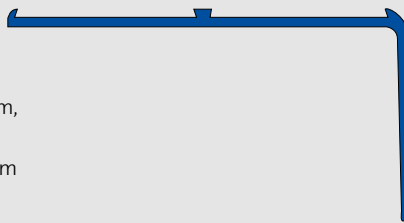

AA 201

TREDSAFE

for 2 x insert, 37 mm

Material: Aluminium, silver anodised

Visible width: 87 mm

Heights: 28 mm (AA 202), 39 mm (AA 205)

Lengths: 250 cm



AA 202 / 205

TREDSAFE

for 2 x insert, 37 mm

Material: Aluminium, silver anodised

Visible width: 86 mm

Height: 27 mm

Lengths: 250 cm

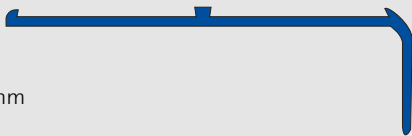

AA 204

TREDSAFE

for 2 x insert, 37 mm

Material: Aluminium, silver anodised

Visible width: 86 mm

Height: 27 mm

Lengths: 250 cm

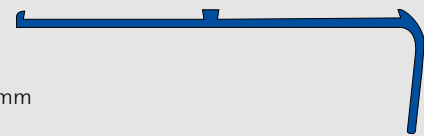

AA 206

TREDSAFE Profiles

with integrated flooring groove for steps with carpeted and vinyl flooring.

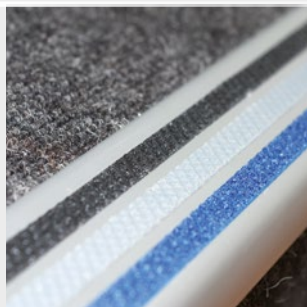

TREDSAFE

for 1 x insert, 43 mm

Material: Aluminium, silver anodised

Visible width: 57 mm

Height: 44 mm

Lengths: 250 cm

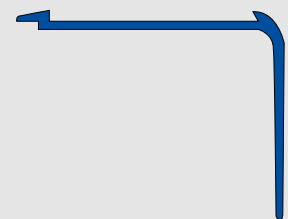

AA 108

TREDSAFE

for 1 x insert, 53 mm

Material: Aluminium, silver anodised

Visible width: 61 mm

Height: 47 mm

Lengths: 250 cm

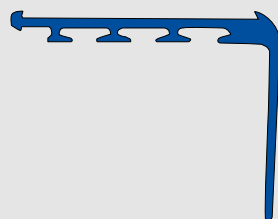

AA 123

TREDSAFE

for 3 x insert, 13 mm

Material: Aluminium, silver anodised

Visible width: 76 mm

Height: 35 mm

Lengths: 250 cm

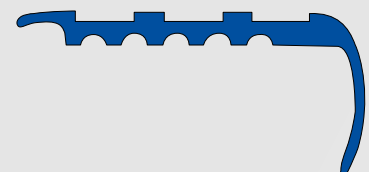

AA 345

DESIGN AND SAFETY

The DURAL stair nosing profile collection makes a significant contribution to barrier-free living in sustainable construction and renovation projects. It is important to keep rooms with different flooring heights and areas with several storeys accessible and liveable for the less mobile such as older or disabled people. Walking aids have a better grip on anti-slip steps on indoor and external stairways, maintaining mobility for much longer.

In combination with the TAKTIL orientation aids, this improves accessibility many times over.

- Steps in buildings accessed by the public and in residential properties can be made as safe as possible by installing visual and tactile contrast and warning areas.
- The warning area on the first and last steps of a flight of stairs is a tactile method used to warn visually impaired people of where stairway starts and ends.
- The contrasting inserts helps to improve the visibility of the edge of the step end when descending steps or stairs. The tactile perception of the surface under foot offers added value in terms of user friendliness.
- The contrasting step edges of the first and last risers helps to improve step visibility from the very first step to the last in a flight of stairs.

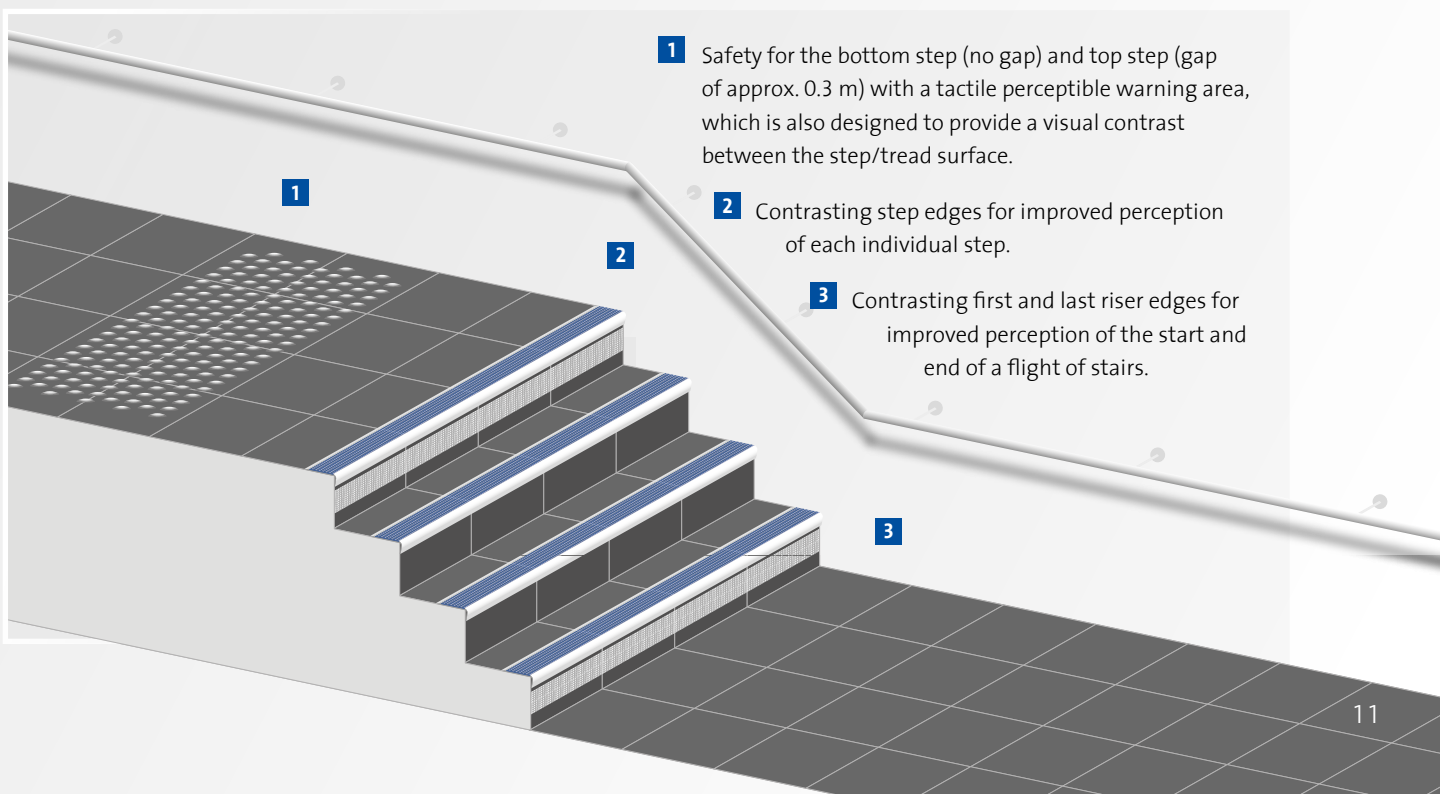
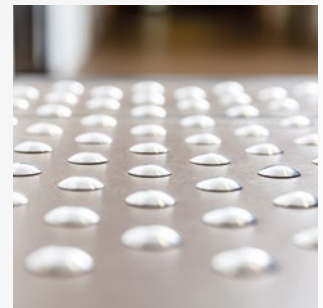

1 Safety for the bottom step (no gap) and top step (gap of approx. 0.3 m) with a tactile perceptible warning area, which is also designed to provide a visual contrast between the step/tread surface.

2 Contrasting step edges for improved perception of each individual step.

3 Contrasting first and last riser edges for improved perception of the start and end of a flight of stairs.

STAIR NOSING PROFILES FOR TILES



FLORENTOSTEP-LED	13
FLORENTOSTEP	14
DURASTEP-WOOD	16
<i>Provence</i>	16
<i>Toscana</i>	16
DURASTEP <i>Solid</i>	17
DURASTEP <i>Standard</i>	17
DURASTEP <i>Jumbo</i>	17

FLORENTOSTEP-LED

Illuminated stair nosing profile with a florentine design



- Illuminated stair nosing profiles in a florentine design for steps with tiled or natural stone surfaces in indoor and external areas
- High-quality lighting for steps and stairs.
- Illuminated stair nosing profiles offer enhanced visible safety.
- LED strips are also suitable for use outdoors if protected or cover is provided.
- Comprehensive range of control and connection accessories.
- FLORENTOSTEP-LED 8-step set for the complete installation of an 8-step stairway including wiring and transformer.
- FLORENTOSTEP-LED 1-step set for the complete installation of a single step including wiring (without transformer) for connection to the complete set.

FLORENTOSTEP-LED Complete profile

without LED strip
Material: Aluminium, silver anodised
Heights: 9, 11 mm
Width: 20 mm
Length: 250 cm

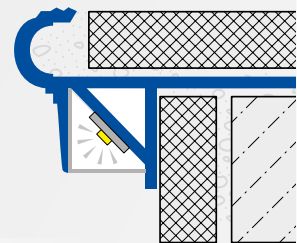

FLORENTOSTEP-LED 8-step set

Material: Aluminium, silver anodised
Heights: 9, 11 mm
Visible width: 20 mm
Length: 250 cm
includes connection cable and transformer

FLORENTOSTEP-LED 1-step set

Material: Aluminium, silver anodised
Heights: 9, 11 mm
Visible width: 20 mm
Length: 250 cm
includes connection cable

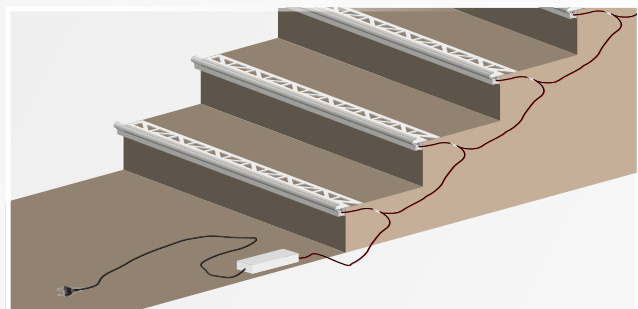
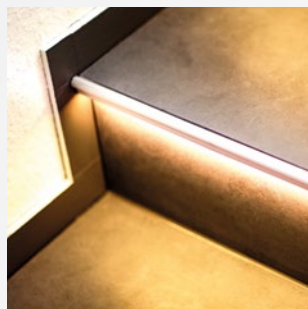

FLORENTOSTEP

Highly decorative stair nosing profile



The timeless elegance of its florentine design and high loading capacity make the highly decorative FLORENTO-STEP stair nosing profile idea for the safe and secure protection of step edges in all areas, indoors and externally, in residential or public buildings and offices. The extra-wide carrier profile is perfectly matched to the respective profile height and gives the step edge permanent additional stability. Available materials are aluminium, brass and stainless steel (V2A) in a wide range of elegant finishes.

- **Decorative profile in a florentine style**
- **Extremely high foot traffic areas**
- **Available in many elegant finishes**



Aluminium



Aluminium Z-Flex



Stainless steel

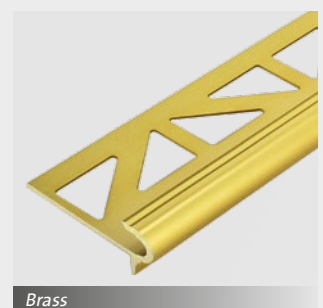

Brass

**FLORENTOSTEP
Brass**

Finishes: natural, chrome-plated, high-gloss polished
Heights: 7, 9, 11 mm
Lengths: 100, 250 cm

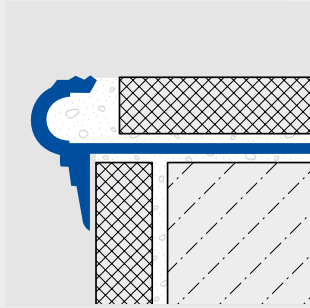

**FLORENTOSTEP
Stainless steel V2A**

Finishes: natural, high-gloss polished, brushed finish
Heights: 9, 11 mm
Lengths: 100, 250 cm

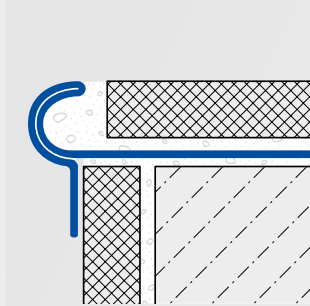

**FLORENTOSTEP
Aluminium**

Finishes: natural, anodised
Colours: silver, gold, champagne, titanium
Heights: 7, 9, 11, 13.5 mm
Length: 250 cm

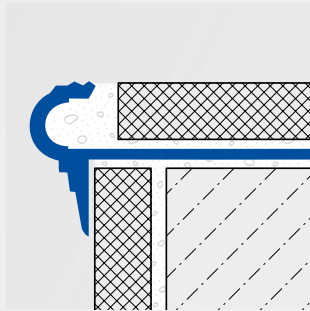

**FLORENTOSTEP
Z-Flex**

Material: Aluminium
Finishes: natural, silver anodised
Heights: 7, 9, 11, 13.5 mm
Length: 250 cm

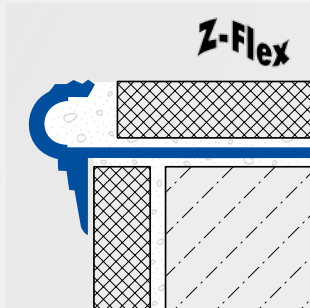

**FLORENTOSTEP
External corner**

Material: die-cast metal
Colours: silver, gold, champagne, titanium
Heights: 7, 9, 11, 13.5 mm



**FLORENTOSTEP
Internal corner**

Material: die-cast metal
Colours: silver, gold, champagne, titanium
Heights: 7, 9, 11, 13.5 mm

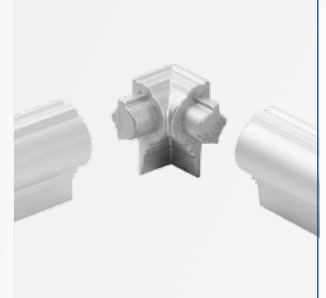

**FLORENTOSTEP
End cap (left)**

Material: die-cast metal
Colours: silver, gold, champagne, titanium
Heights: 7, 9, 11, 13.5 mm

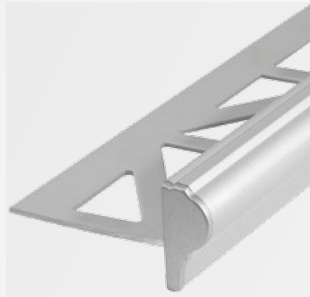

**FLORENTOSTEP
End cap (right)**

Material: die-cast metal
Colours: silver, gold, champagne, titanium
Heights: 7, 9, 11, 13.5 mm

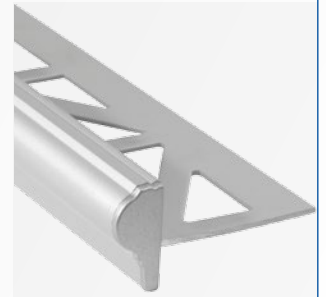

DURASTEP-WOOD

Stair nosing profile with a solid wood tread



DURASTEP-WOOD are extraordinary stair nosing profiles with a solid wood tread. This protects not only the front edges of the steps, but also gives the entire stairway a special mediterranean flair. The aluminium carrier profile guarantees optimum anchoring to the tiled surface.

- High-quality genuine wood step edge
- Decorative profile with a mediterranean flair



Provence

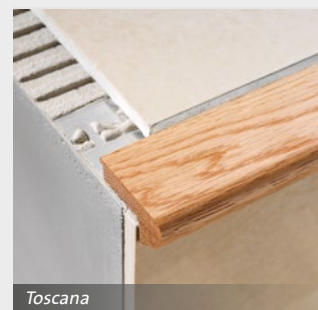

Toscana

DURASTEP-WOOD *Provence*

DURASTEP-WOOD elegant stair nosing profiles in the *Provence* version have a narrow visible edge, making them extremely attractive. The finely grained oakwood fits harmoniously into any interior design theme.

- Visible edge curves downwards
- For internal areas

DURASTEP-WOOD *Provence*

Material: Aluminium / Wood
 Heights: 10, 13.5 mm
 Visible width: 50 mm
 Lengths: 100, 250 cm

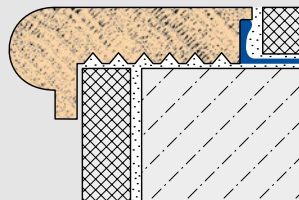

DURASTEP-WOOD *Toscana*

DURASTEP-WOOD stair nosing profiles in the *Toscana* version are distinctive but nevertheless imaginative. The strong downward curving visible edge in fine grained oak lends every single step a refined appearance.

- Visible edge curves downwards distinctively
- For internal areas

DURASTEP-WOOD *Toscana*

Material: Aluminium / Wood
 Heights: 10, 13.5 mm
 Visible width: 50 mm
 Lengths: 100, 250 cm

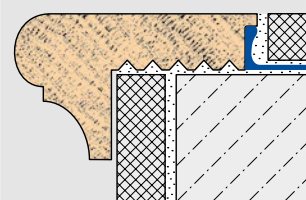

DURASTEP

Metal stair nosing profile, stair nosing profile with PVC insert

DURASTEP *Solid*

DURASTEP *Solid* is a stair nosing profile in aluminium or for high footfall V2A stainless steel for the safe and attractive production of step edging. These profiles can be used internally in residential and commercial buildings (V2A stainless steel also suitable for use externally) in areas which are accessed on a moderately frequent basis.

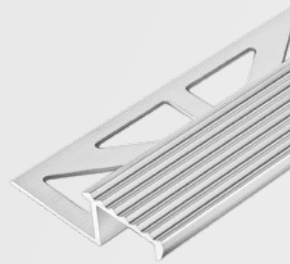

DURASTEP *Solid* Aluminium

Finishes: natural, silver anodised
Heights: 9, 11 mm
Visible width: 20 mm
Lengths: 150*, 250, 300 cm
*silver anodised only

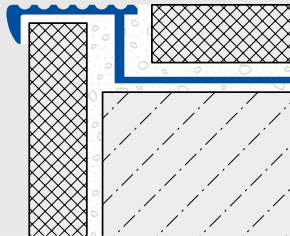

DURASTEP *Solid* Stainless steel V2A

Heights: 9, 11, 13,5* mm
Visible width: 30 mm
Lengths: 150, 250 cm
*for 250 cm length only

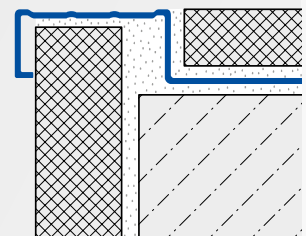

DURASTEP *Standard*

DURASTEP *Standard* is a stair nosing profile with a high footfall capacity for private areas. The 25 mm-wide PVC inserts are available in five different colours and can be replaced as required.

DURASTEP *Standard*

Material: Aluminium / PVC
Insert colours: white, beige, black, brown, grey
Heights: 7, 9, 11 mm
Visible width: 25 mm
Lengths: 100, 250 cm

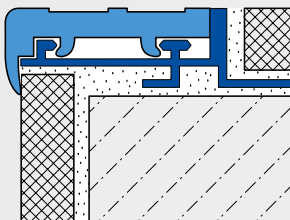

DURASTEP *Jumbo*

DURASTEP *Jumbo* profiles are ideal for any busy public or commercial locations. The aluminium carried profile guarantees safe and secure anchoring in the flooring construction. The 35 mm wide PVC inserts cope with high footfall and offers excellent anti-slip properties and can also be replaced as required.

DURASTEP *Jumbo*

Material: Aluminium / PVC
Insert colours: white, beige, black, brown, grey
Heights: 7, 9, 11 mm
Visible width: 35 mm
Lengths: 100, 250 cm

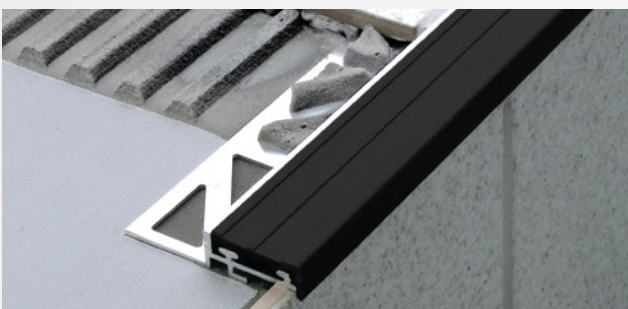
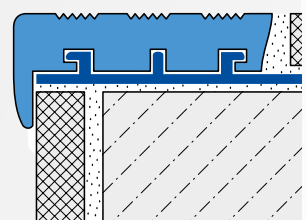

STAIR NOSING PROFILES

FOR FLOORING SURFACES

PROTECT	19
STEP	20
SOFT	20
TEKA	21
LINO	21
STEPFLOOR	22
STEPFLOOR-G	22
CLIPPER <i>Step</i>	23
REWI	23



PROTECT

Stair nosing profile for retrofitting



PROTECT stair nosing profiles make every edge attractive and safe to walk on. Available in natural or anodised aluminium, or stainless steel (V2A), pre-drilled for installation using screws or self-adhesive.

- Easy installation
- Anti-slip step edge
- High quality metal finishes

PROTECT Aluminium / Wood finish*

undrilled, self-adhesive
 Height x Width:
 10 x 25 mm, 20 x 20 mm
 Lengths: 90, 100, 270 cm

*maple, light maple, beech, cherry, oak, antique oak, rustic oak, walnut, wenge

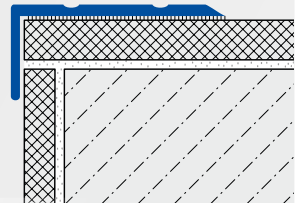

PROTECT Aluminium, corrugated

drilled / undrilled
 Colours: silver, gold, bronze
 Height x Width:
 10 x 25 mm, 20 x 25 mm
 Lengths: 90, 100, 270 cm

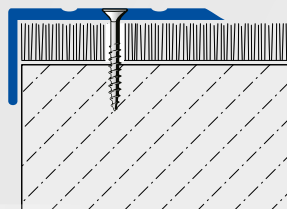

PROTECT Aluminium, grooved

drilled / undrilled
 Colours: silver, gold, bronze
 Height x Width:
 20 x 40 mm, 40 x 45 mm*
 Lengths: 90, 100, 250, 270 cm

*for 250 cm length only

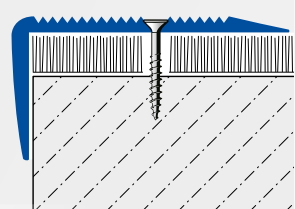

PROTECT Brass

drilled / undrilled
 Finish: high-gloss polished
 Height x Width:
 20 x 20 mm, 30 x 30 mm
 Length: 250 cm

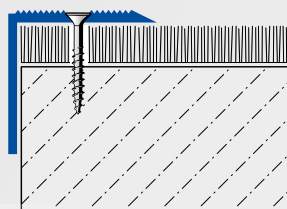

PROTECT Stainless steel V2A

Height x width:
 17 x 34 mm
 Length: 250 cm

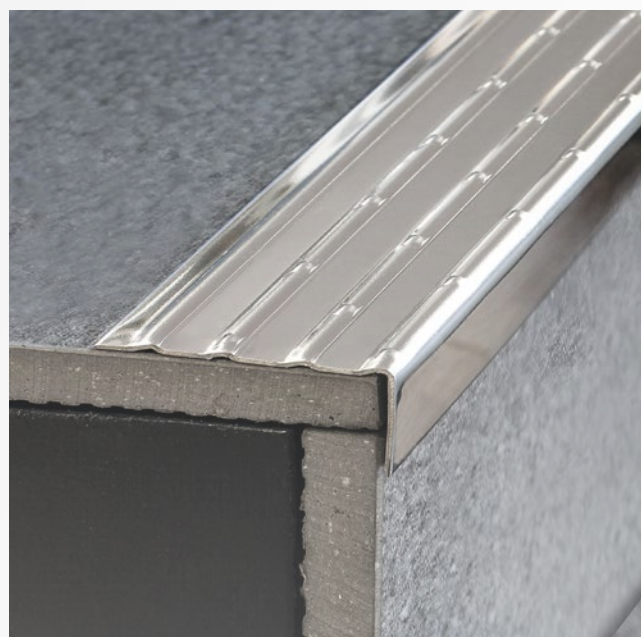
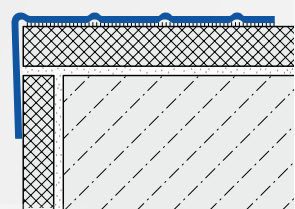

STEP

Stair nosing profile with a PVC insert for retrofitting

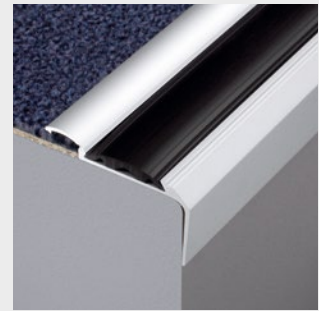

Stair nosing profile as edge protection available in various shapes and dimensions. Interchangeable PVC inserts guarantee slip-proof hold. Having invisible fixings underneath the inserts using screws and dowels.

- A range of transitions with the flooring surface is available
- Replaceable inserts

STEP for smooth / grooved insert

Material: Aluminium anodised
Colours: silver, gold, bronze
Length: 250 cm

Insert: PVC, smooth / grooved
Width: 28 mm
Roll: 25 m

Height: 12 mm
Width: 45 mm

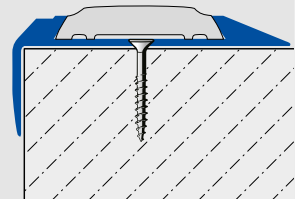

STEP for self-adhesive insert

Material: Aluminium anodised
Colours: silver, gold, bronze
Height: 17 mm, Width: 36 mm
Length: 270 cm

Insert: PVC, black, brown
Width: 13 mm, Roll: 25 m

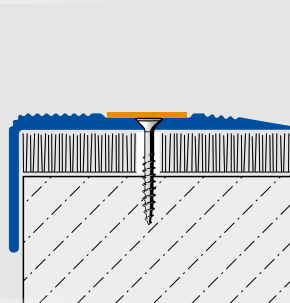

Height: 27 mm
Width: 49 mm

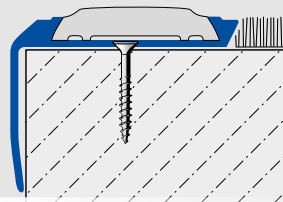

Height: 27 mm
Width: 49 mm

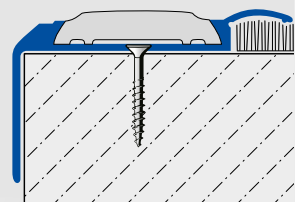

SOFT

Stair nosing profile in PVC

SOFT

Material: PVC
Colours: black, brown, grey
Height: 38 mm
Width: 34 mm
Length: 250 cm

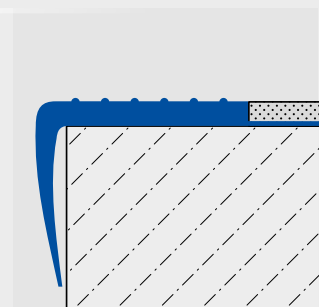

SOFT profiles in soft PVC are ideal for the most varied applications, to create perfect flush finishes in combination with thin-layered flooring surfaces: The elastic plastic angles fit perfectly with the shape of the step.

- Elegant appearance
- Quick and easy installation

SOFT

Material: PVC
Colours: black, brown, grey
Height: 37 mm
Width: 39 mm
Length: 250 cm

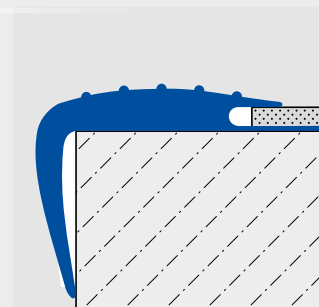

TEKA

Push-in stair nosing profile

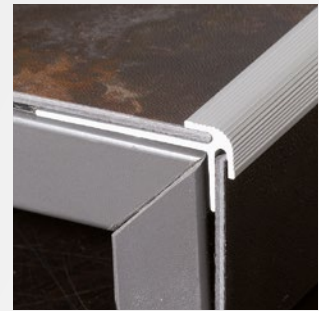
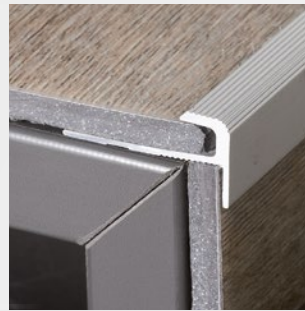

Rounded edge termination profile with an anti-slip surface for the insertion of design and carpeted flooring. Clean, safe and secure terminations for floors or steps.

- Various profile cross-sections
- Surface exceptionally safe to walk on
- Extremely high loading properties

TEKA

Material: Aluminium, silver anodised
Heights: 2.5, 3.5, 5, 6 mm
Length: 300 cm

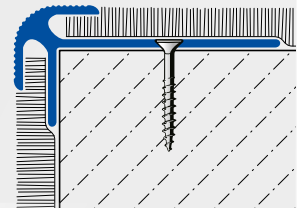

TEKA

Material: Aluminium anodised
Colours: silver, gold, bronze
Push-in height: 5 mm
Width: 32 mm
Length: 270 cm

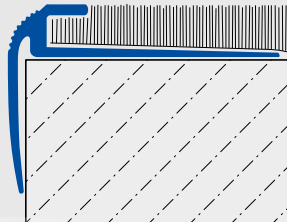

TEKA

Material: Aluminium anodised
Colours: silver, gold, bronze
Push-in height: 5 mm
Width: 29 mm
Length: 270 cm

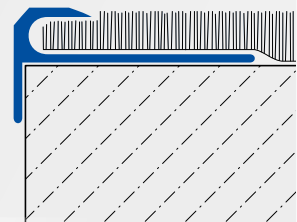

LINO

Extra-flat stair nosing profile



LINO is the profile system specially designed for extra-thin flooring surfaces. Flat and elegant, they fit harmoniously into every design scheme.

- Specially designed for linoleum flooring
- Also as a transition profile

LINO

Material: Aluminium, silver anodised
Width: 35 mm
Height: 2.5 mm
Length: 270 cm

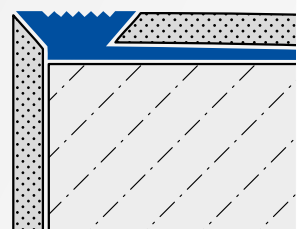

STEPFLOOR

Push-in Stair nosing profile



An attractive aluminium push-in profile in a florentine design for step edges with laminate or parquet flooring surfaces. Available in a range of different colours, anodised or with a decorative wood finish.

- Profile with an extremely high loading capacity
- Elegant rounded edge



STEPFLOOR Aluminium anodised

Colours: silver, gold, bronze, champagne

Heights: 8–10 mm, 14–16 mm

Visible width: 20, 25 mm

Width of base: 46, 50 mm

Length: 270 cm

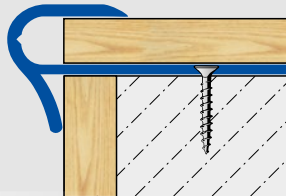

STEPFLOOR Aluminium / Wood finish*

Heights: 8–10 mm, 14–16 mm

Visible width: 20, 25 mm

Width of base: 46, 50 mm

Length: 270 cm

*maple, light maple, beech, cherry, oak, antique oak, rustic oak, kempas, merbau, walnut, wenge

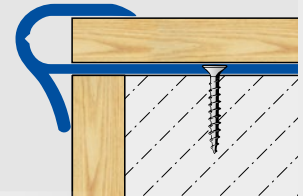

STEPFLOOR-G

Push-in stair nosing profile



Angled push-in profile in aluminium with a grooved surface for step edges with laminate or parquet flooring surfaces. The profiles are fastened using screws.

- Profile with an extremely high loading capacity
- Safe to walk on thanks to grooved surface

STEPFLOOR-G

Material: Aluminium anodised

Colours: silver, gold

Heights: 8, 14 mm

Visible width: 15 mm

Width of base: 35 mm

Lengths: 90, 270 cm

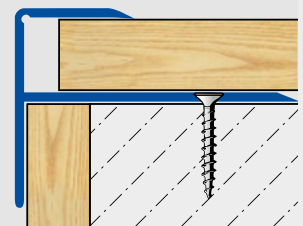

CLIPPER Step

Stair nosing profile with a click system



CLIPPER Step is the stair nosing profile for screwless fastening of the top profile. The three-part construction consisting of a solid aluminium base profile, the plastic clip and the top profile facilitates their use in practically all areas with a harmonised appearance.

- Concealed top profile fastening mechanism
- Base profile is anchored securely using screws

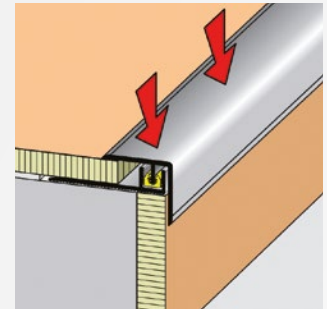
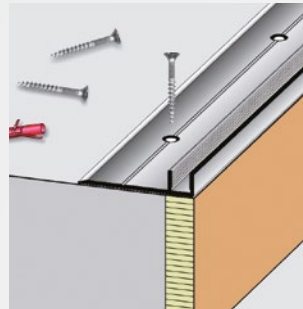

CLIPPER Step Aluminium anodised

Colours: silver, gold, bronze, champagne, titanium
Height: 7–10 mm
Width: 22 mm
Lengths: 90, 270 cm

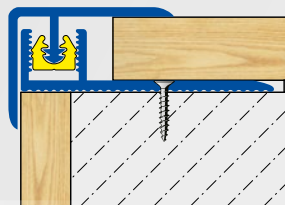

CLIPPER Step Aluminium / Wood finish*

Height: 7–10 mm
Width: 22 mm
Lengths: 90, 270 cm

*maple, light maple, beech, cherry, oak, antique oak, rustic oak, kempas, merbau, walnut, wenge

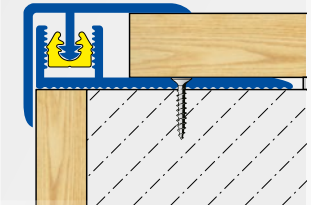

REWI

Stair nosing renovation profile



Stair nosing repair profile in galvanised steel for the simple and permanent reinforcement of old or damaged wooden or concrete steps or stairs. All REWI profiles are pre-drilled for safe and secure fastening.

- Permanent renovation of old or damaged step edges
- For all carpeted and design flooring

REWI for concrete

Material: Galvanised steel
Height: 20 mm
Length: 100 cm

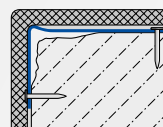

REWI for wood

Material: Galvanised steel
Heights: 20, 38 mm
Length: 100 cm

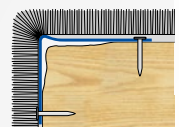

DURAL is a comprehensive provider of floor-level shower systems, profiles and matting systems for walls and floors



Stair nosing profiles

Floor level shower systems

LED profiles and accessories

Skirting

Balconies / Terraces / Entranceways

Tactile orientation aids

Doormat systems

Profile systems for parquet, laminate, carpet and designer flooring

Tile profiles
Expansion joint profiles
Z-Flex

Matting systems for decoupling, drainage, sealing and insulation

Recommended by:

DURAL GmbH
Südring 11
D-56412 Ruppach-Goldhausen
Tel. +49[0]2602/9261-0
Fax +49[0]2602/9261-50
info@dural.com
www.dural.com