

# ILLUMINATED FOR TILES AND NATURAL STONE SURFACES

## TILE PROFILES

USER  
INFORMATION

**DURAL**

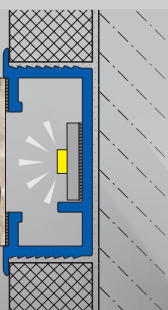
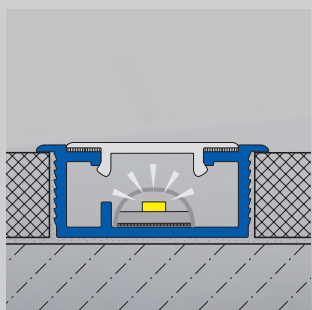
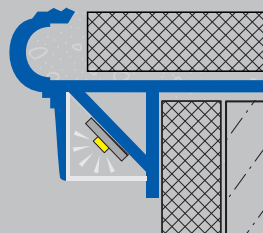
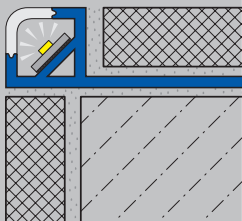

PROFILE TECHNOLOGY

PROFILES OVERVIEW

LED STRIPS

ACCESSORIES

TRANSFORMERS

CONTROL

INSTALLATION/  
NEW CONNECTION  
LED STRIPS  
IP20 / IP65

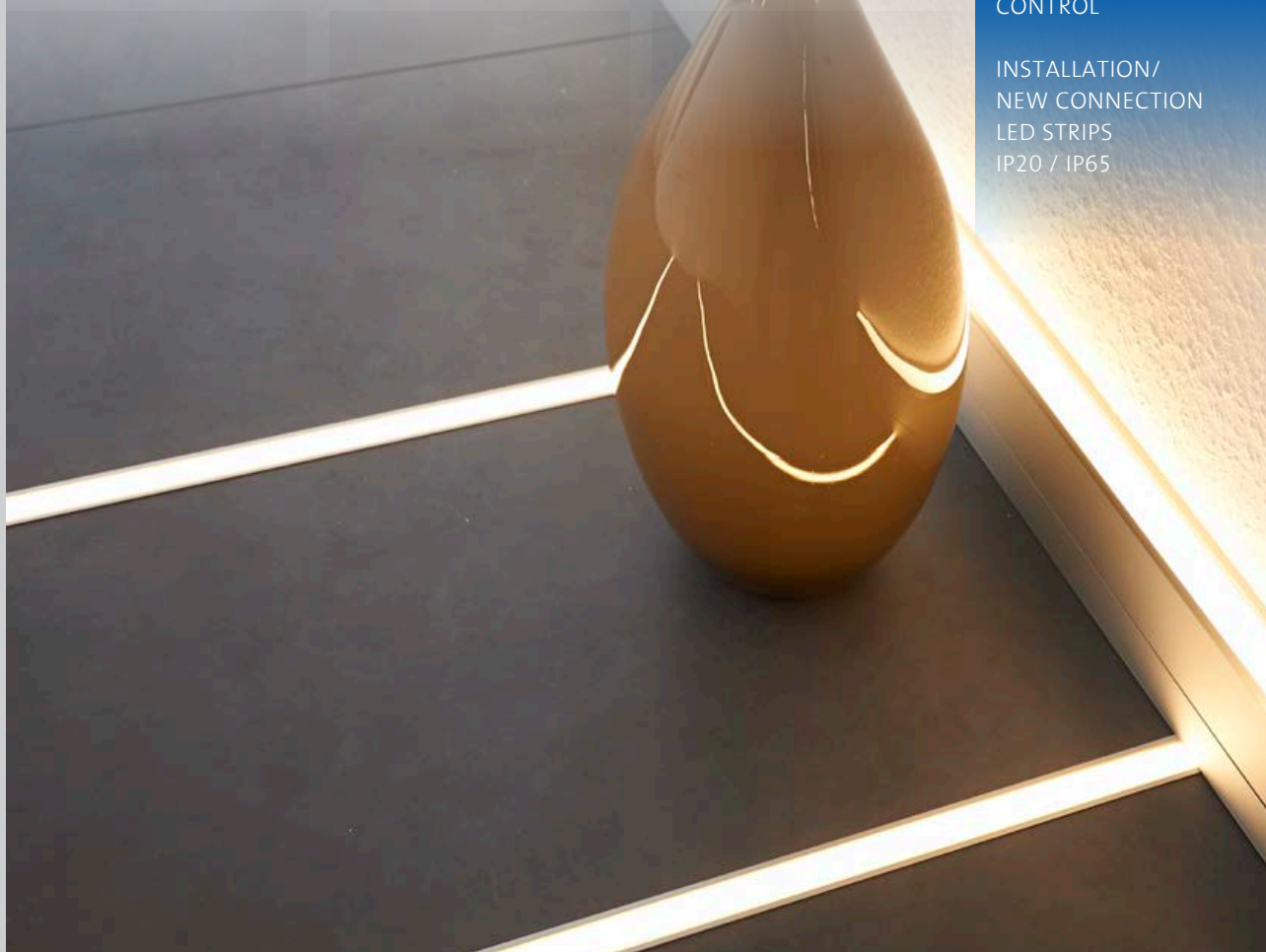

# LED ILLUMINATED TILE PROFILES

## User Information: Profile Technology

### LIGHT IS DESIGN IN THE ROOM

The significance of light has changed in recent years. Once a primarily practical tool for the purpose of illumination, nowadays, light is also widely used to accentuate and to create a special ambience or atmosphere. Installed outdoors on a façade, or as part of an indirect lighting scheme in a living room, light as a design element is now an indispensable feature of every residential space.

Taken a logical step further, floor and wall surfaces in bathrooms and kitchens, as well as in foyers, hallways or bedrooms, offer a vast number of possibilities for the use of light to create a certain ambience and to give a living area a special individual flair.

### THE BASIS: HIGH-QUALITY PROFILES AND COVERS

DURAL has over 30 years of experience as the specialist for all types of tile profile. This experience is also reflected in the illuminated tile profiles.

- **SQUARELIGHT-LED** - For vertical and horizontal edges of storage surfaces, skirting, sockets or niches, available with a choice of a round or square cover.
- **DURALIS-LED-Floor/Wall** – Listello profiles for decorative ambient lighting of walls and flooring, both indoors and outdoors.
- **DURALIS-Stone** – Listello profiles with a genuine natural stone inlay for extraordinary light accents on wall surfaces.
- **FLORENTOSTEP-LED** step nosing profiles with a Florentine design for steps and stairs with natural stone or tiled surfaces, suitable for use both indoors and in protected outdoor areas

Illuminated tile profiles from Dural deliver the diversity you desire. Thanks to a comprehensive range of accessories, switches and connection materials, you have complete freedom to realise all your lighting ideas in almost every single space or room. The system has a modular design, which means components match perfectly and fit easily together and in each other. The individual elements are easily combinable.

We have selected our components very carefully, with special consideration given to their robustness and fault tolerance. It is practically impossible to make any mistake which might damage the LEDs or their accessories.

Basic profiles in high-quality aluminium and a translucent cover form one unit. The basic profile guarantees secure installation and stability and the translucent cover scatters the light, providing even and attractive light distribution.

The basic profiles are installed in the usual way as per the "normal" tile profiles from DURAL. No special adhesives, special grout or special tools are required. The profiles have the usual length of 2.5 metres (DURALIS-Stone 2.40 m) and are supplied as a complete profile (basic profile including translucent cover) without LED strips. Naturally, the basic profile and the LED covers are also available individually.

Aluminium profiles offer not only optical advantages, they also divert the heat which is generated into the surrounding wall structure, thereby extending the lifetime of the LEDs.



### SQUARELIGHT-LED



### DURALIS-LED-Wall/Floor



### DURALIS-Stone



### Florentostep-LED

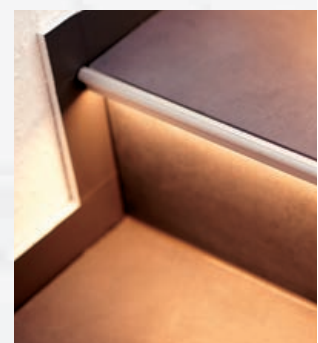

# LED ILLUMINATED TILE PROFILES



## User Information: Profile Overview

### Illuminated edge profiles

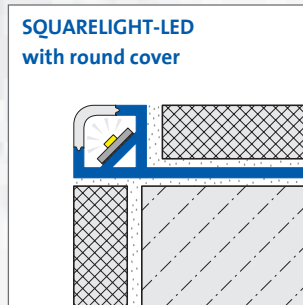
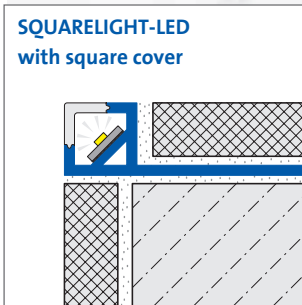

### Illuminated decorative profiles

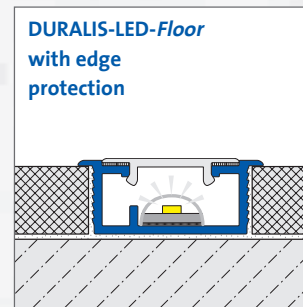
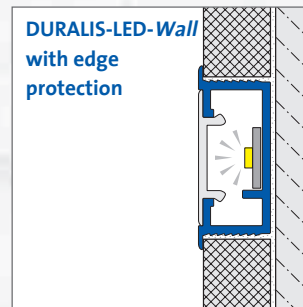
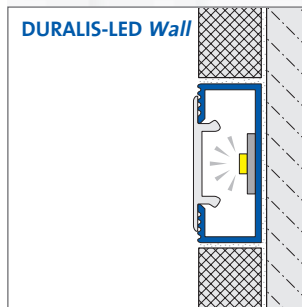

### Illuminated decorative profiles with a natural stone inlay

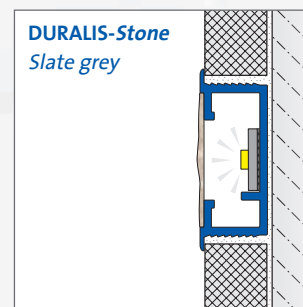
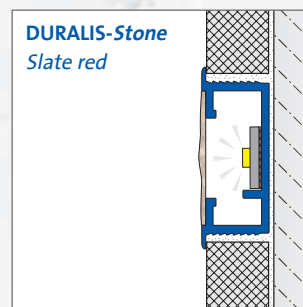
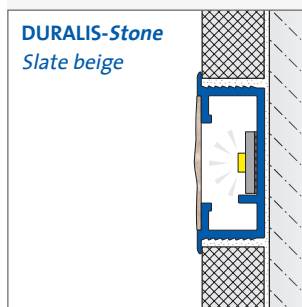

### Illuminated step nosing profiles

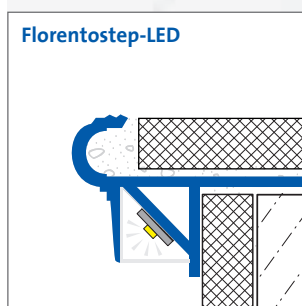

# LED ILLUMINATED TILE PROFILES

## User Information: LED strips

### THE DIVERSITY OF LIGHT: LED STRIPS

The heart of the illuminated tile profiles is of course the LEDs. They are available in various lengths and in two different variants.

- For use in living areas corresponding to protection class IP 20.
- For use in wet or humid areas (e.g. bathrooms) with silicone protection corresponding to protection class IP 65.

For installation in showers and wet rooms, protection in protection class IP67/68 will be necessary. This can be achieved using the IP20 strips in combination with the LED-WaterProtect set, which is available as accessory equipment. LED-WaterProtect is not suitable for use in steam rooms and saunas etc. Please use the special products which have been approved for these applications.

For both strip types, 120 LEDs/running metre provide a maximum level of evenly distributed light with a power consumption of just 7 W/running metre. The basic colour is warm-white and is continuously dimmable. An RGB/W LED strip variant is also available on request (coloured/white).

However, please note that the strips with protection class IP 65 emit a much brighter light than those with protection class IP 20, due to the silicone protection. For this reason, only strips with the same protection class should be installed within one room or field of vision.

The 24 V DC used by the system guarantees the equal brightness of all LEDs, irrespective of the strip length.

LED strips from DURAL are incredibly robust and practically indestructible. If accidentally dropped, they will not be damaged, and even if something falls directly onto the strip, it is unlikely that any damage will occur.

### IMPORTANT:

The LEDs have a lifetime of around 30,000 hours. Under normal operating conditions, replacement will not be necessary, but is generally always possible without needing to dismantle the profile. To do so, first remove the translucent cover and use a sharp knife to cut away the insulation from the connections. The exposed wires are released from the strip using a soldering iron and then resoldered onto the new strip.

To shorten the strips, please see our instructions on page 8/9, or online at [www.dural.de](http://www.dural.de).

# DURAL



### LED profile lighting in the living room/ bedroom



### LED profile lighting in the kitchen



### LED profile lighting in the bathroom



### LED profile lighting in the hall/corridor/foyer

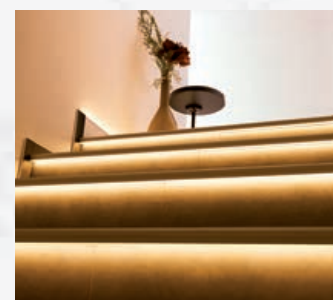

# LED ILLUMINATED TILE PROFILES



## User Information: Accessories

### ALWAYS THE PERFECT MATCH: OUR COMPREHENSIVE RANGE OF ACCESSORIES

The offer ranges from transformers with various ratings, extension cables and a small direct connector, perfectly customised for connection of the strips. To help you position your illuminated tile profiles exactly where you wish.

Control is possible from practically any point in the room using a wide range of switches and dimmers, for fixed installation, using remote control, or via a Smartphone app. All system components are combinable, always using a standardised JMT connector plug.

Transformers



LED strips RGB-W  
on request



LED wireless receiver  
for up to 6 dimmers



LED wireless receiver  
Recessed wall dimmer



LED wireless dimmer  
Table-mounted dimmer



Remote control with holder



Touch-sensor switch for flush  
mounting



Bluetooth module



ON/OFF touch switch  
ON/OFF dimmer switch  
with distribution box



LED-WaterProtect  
For use in showers  
and wet rooms (IP 67 / 68)



Direct connector for LED strips



Connection and  
extension cable



# LED ILLUMINATED TILE PROFILES

## User Information: Transformers

**DURAL**

### **WARNING! ELECTRICITY: SAFE AND HARMLESS**

All current-carrying (live) parts "behind" the transformer operate using the harmless 24 V DC constant voltage. This voltage is far too low to be dangerous. You could even touch the strip connections directly without noticing it.

The transformers are fitted with a standard commercially available Schuko plug, which allows them to be plugged into any socket. All components have TÜV, CE, GS und MM certification.

### **OF CENTRAL IMPORTANCE: THE TRANSFORMER**

A transformer with the correct power rating is necessary to supply power safely to the LEDs. Choosing the right transformer rating is extremely easy. The power requirement of the warm-white LED is 7 W/running metre and for safety reasons, an additional 10% power loss due to wiring, switches etc. should be taken into account. Thus the following strip lengths can be used as a guideline:

**15 W transformer = max. approx. 1.9 m strips**

**30 W transformer = max. approx. 3.8 m strips**

**50 W transformer = max. approx. 6.5 m strips**

These values only apply to the orientation for DURAL-LEDs in warm-white. Coloured RGB/W strips have a higher power consumption, consequently transformers with a correspondingly higher power rating must be installed. A transformer with a rating which is too high will not affect the functionality of the system.

The transformers are equipped with a thermostat, which safely prevents any overheating.

If individual components are connected incorrectly, or a transformer overloaded, the components will not be damaged and will continue to function perfectly after the error is corrected. Even the building's main distribution board will not be affected or damaged.

If you accidentally install a transformer with a rating which is too low, the LEDs will flash briefly and then go out. As soon as you connect the correctly rated transformer, the LEDs will function again. The wrong transformer has not been damaged and can be used again.

### **TRANSFORMER 75/100/150 W**

Transformers with power ratings of 75 W, 100 W und 150 W are available on request. Please note that transformers may only be installed by authorised and qualified technicians. The generally recognised rules of good engineering practice must always be observed.

### **IMPORTANT:**

As is the case for transformers for low-voltage halogen lighting, with transformers for low-voltage LEDs, the possibility of replacement after many years of operation should not be excluded. For this reason, the transformer should always be positioned in a location in which it is easily accessible in case of any doubt.

Transformers



# LED ILLUMINATED TILE PROFILES

## User Information: Control

### INSTALLATION: EASY TO PLAN

As straightforward as the installation may be in principle, it is always necessary to plan fully in advance which components you will need and how these will be switched. If the wall is already tiled, correcting any mistakes will involve a great deal of effort. The first question you will need to ask is whether the LED circuit will be connect to the main light

in the room, or whether it will be switched independently. The most basic, or simple variant, is the independent circuit. Simply plug the transformer into a socket supplying a direct current and then install the on/off switch, dimmer, distributor or remote control between the transformer and the LED strip.

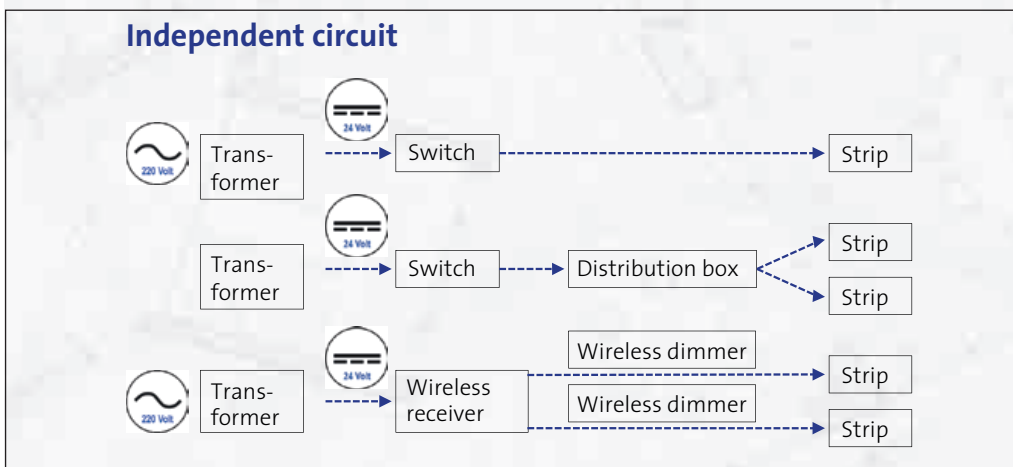

However, you can also control the transformer directly via the main room switch. For this purpose, it will be sufficient to connect the transformer to a switched socket, for example. The LEDs will then emit light as soon as the light switch is operated. If a motion detector or dimmer is installed instead of an on/off switch, the LEDs will be switched or dimmed automatically together with the main lighting. Even if you choose this variant, it is still possible

to switch the LEDs on and off again separately, or to dim them independently of the main lighting. To do so, the corresponding components are installed behind the transformer, in the same way which is described for the independent circuit. However, you must use a wireless dimmer/switch. The flush-mounted switches do not memorise the last status and are set as standard to "off".

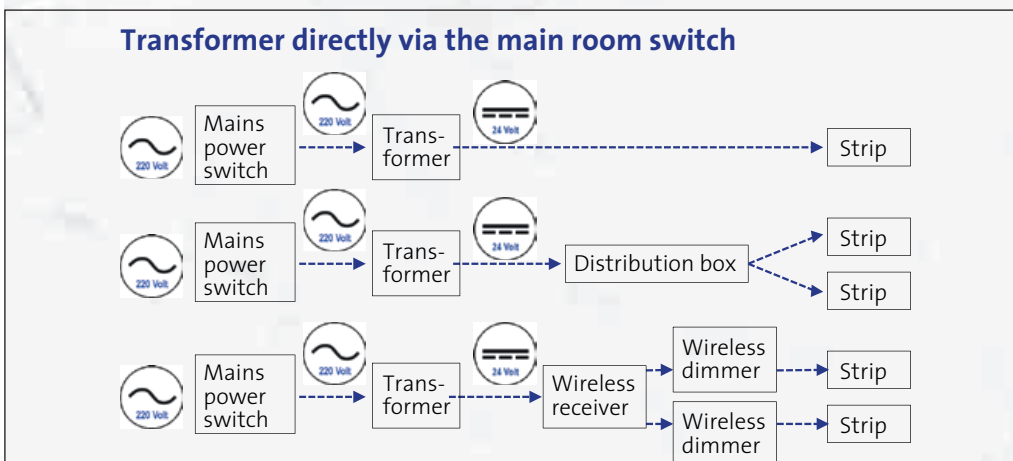

For both variants, please ensure that you position the transformers so that they are easily accessible.

**The generally recognised rules of good engineering practice must always be observed.**

# LED ILLUMINATED TILE PROFILES

## User Information:

### Installation/new connection of cut strips with IP 20

1. Never cut the strip in the centre, otherwise there will be insufficient copper left over to make the new connection.



2. Always cut the strip immediately to the right or the left of the LED.

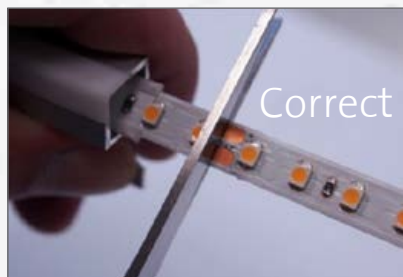

3. Insert the LED strip into the existing insertion aid on the clip.



4. Slide in the strip below the existing contacts. Pay attention to the positive/negative polarity.

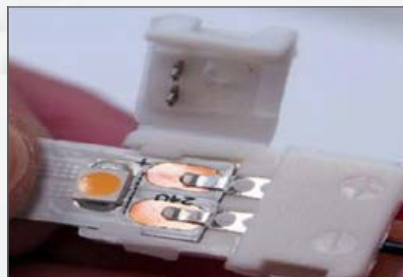

5. Close the clip until it engages. The first LED is immediately adjacent to the clip. This has no effect on the LED or the plastic.



6. Connection to the transformer.

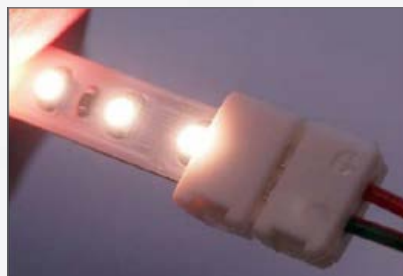



# LED ILLUMINATED TILE PROFILES

## User Information:

### Installation/new connection of cut strips with IP 65

1. Use a cutter or knife to cut the silicone cleanly and **directly** at the LED down to the copper conductor base.



2. Bend the strip slightly at the cut surface. In this photo, the silicone is clearly coming away. If the cut was not deep enough, please rework.

**This action automatically invalidates the IP 65 protection.**



3. If the silicone has been cleanly separated down to the strip base it will be easier to remove in larger sections.

**IMPORTANT!** All contact points must be clean and free from any traces of silicone.



4. Slide in the strip below the existing contacts.

Pay attention to the positive/negative polarity.

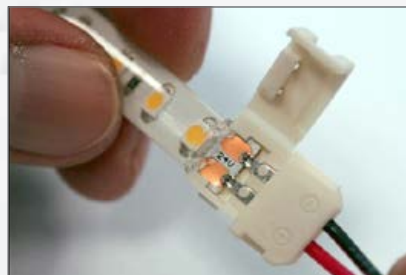

5. Close the clip until it engages. The first LED is immediately adjacent to the clip. This has no effect on the LED or the plastic/silicone.

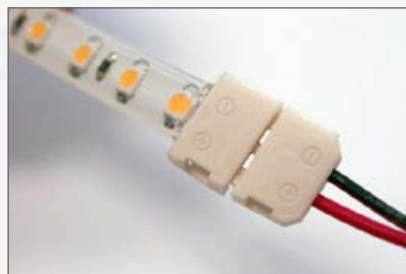

6. Connection to the transformer.



# LED ILLUMINATED TILE PROFILES



## Application information: Installation of LED-WaterProtect

Required accessories



Step 1:  
LED strip IP20 and LED-WaterProtect.



Step 2:  
Connect the LED strip to the insertion aid.



Step 3:  
Slide the LED strip into the tube.



Step 4:  
Carefully pull the LED strip through  
the tube.



# LED ILLUMINATED TILE PROFILES

**DURAL**

## Application information: Installation of LED-WaterProtect

Step 5:

Fill the end caps “to the brim” with 3D silicone.



Step 6:

Attach the end caps to the tube. The 3D silicone must be forced out of the holes.



Step 7:

Insert the Water-Protect strip in the profile.

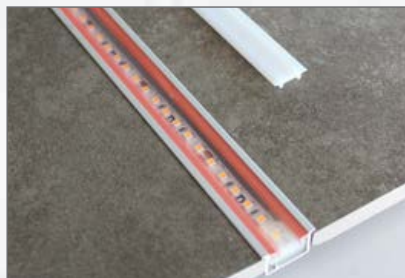

Step 8:

Press on the diffuser and the strip is  
READY TO USE!



With this method, an LED strip with IP20 protection can be turned into a strip with IP67 / 68 protection that can be used in showers or laid in flooring.



DURAL is a comprehensive provider of floor-level shower systems, profiles and matting systems for walls and floors



Stair-edge profiles

Floor level shower systems

LED profiles and accessories

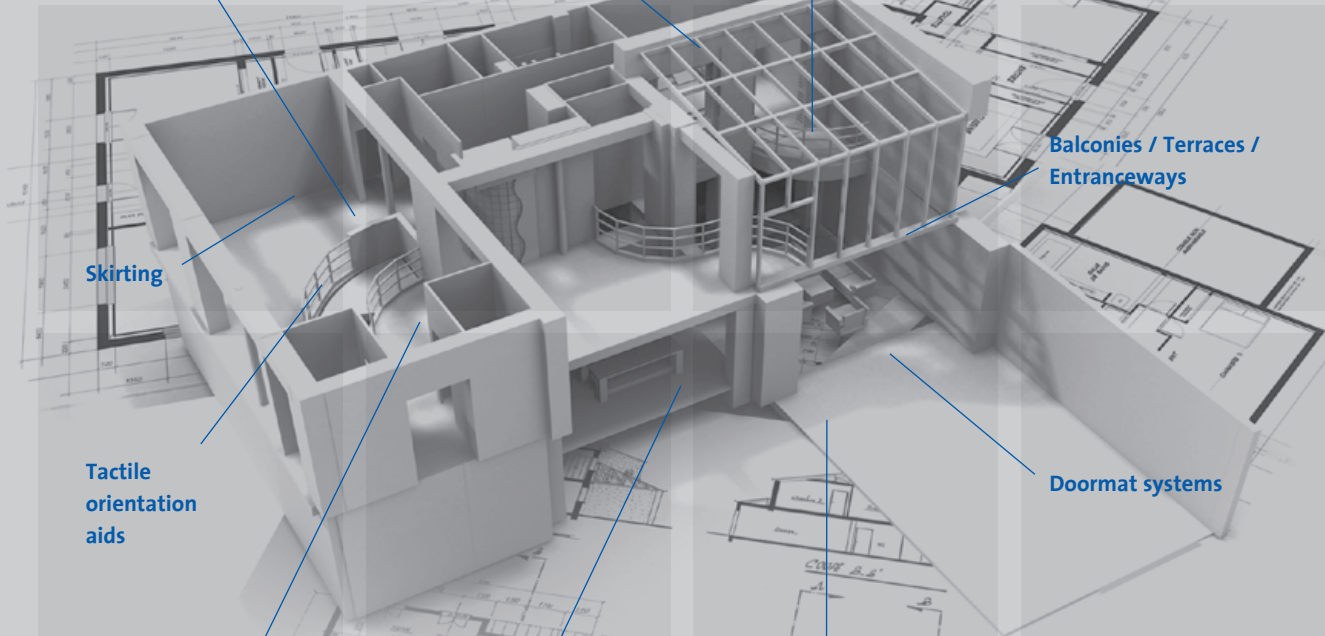

Skirting

Balconies / Terraces / Entranceways

Tactile orientation aids

Doormat systems

Profile systems for parquet, laminate, carpet and designer flooring

Tile profiles  
Expansion joint profiles  
Z-FLEX

Matting systems for decoupling, drainage, sealing and insulation

With the compliments of

**DURAL GMBH**  
Südring 11  
D-56412 Ruppach-Goldhausen  
Tel. +49[0]2602/9261-0  
Fax +49[0]2602/9261-50  
info@dural.com  
www.dural.com