



Πλακίδια υψηλών προδιαγραφών

HI-TECH PROJECT















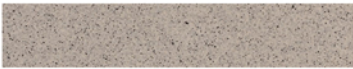





για χώρους με υψηλές απαιτήσεις, όπως: αποθήκες, συνεργεία αυτοκινήτων, γυμναστήρια, κολυμβητήρια, αποδυτήρια, εμπορικά κέντρα, εστιατόρια, σχολεία, δημόσια κτίρια, νοσοκομεία, γραφεία, ελαφριές βιομηχανίες κ.α.

**ADVANCED
CONSTRUCTION
MATERIALS**

Το Hi-Tech Project διαθέτει μια μεγάλη γκάμα από χρώματα και διαφορετικές επιφάνειες. Αυτό σημαίνει ότι μπορούν να ταιριάξουν σε οποιοδήποτε επαγγελματικό χώρο, όπως ακόμα και σε κατοικίες.

Η χρήση των αντιολισθηρών επιφανειών είναι η ιδανική επιλογή όταν πρόκειται για την εξάλειψη του κινδύνου ολίσθησης σε ορισμένους χώρους.

Χρώματα:

	Pompei - RAL1015
	Garda - RAL1015
	Cefalu - RAL7038
	Canazei - RAL7030
	Rimini - RAL3012
	Positano - RAL7032
	Cadore - RAL1015
	Gavello - RAL9002
	Taormina - RAL1019
	Cortina - RAL9001
	Portofino - RAL7044
	Elba - RAL8014
	Siena - RAL8011
	Maremma - RAL6011
	Palmi - RAL3012
	Asciano - RAL8004
	Amelia - RAL1015
	Tropea - RAL1034



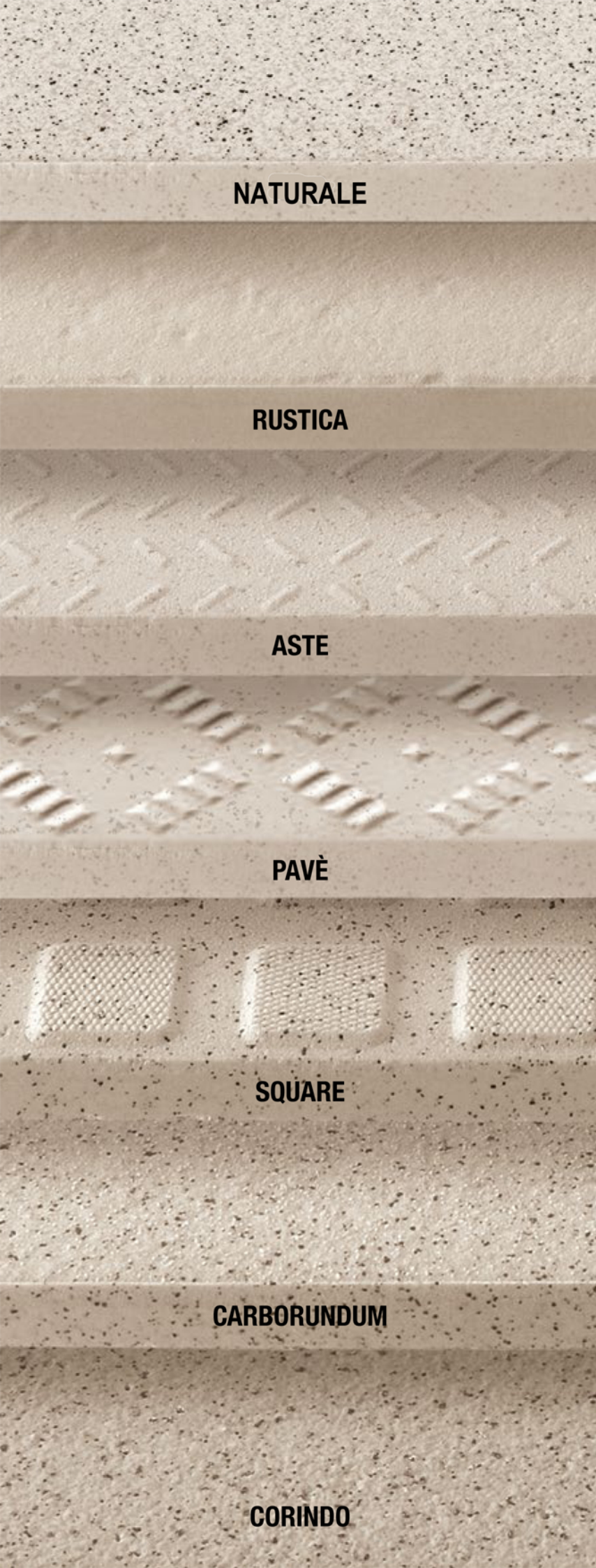

NATURALE

RUSTICA











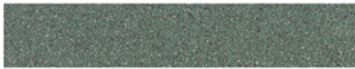

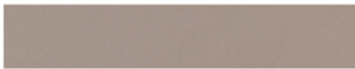
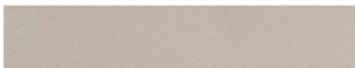
ASTE

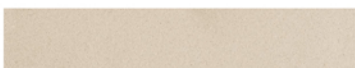
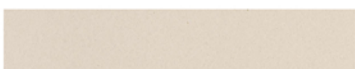
PAVÈ

SQUARE

CARBORUNDUM

CORINDO

Avola - RAL9004	
Anghiari - RAL6028	
Olbia - RAL7001	
Ghiaccio - RAL7035	
Fumo - RAL7003	
Matita - RAL7038	
Ocra - RAL1006	
Avorio - RAL1015	
Panna - RAL9001	
Antrcite - RAL9004	
Cobalto - RAL5024	
Cielo - RAL6034	
Marina - RAL6021	
Smeraldo - RAL6000	
Oumi - RAL1015	
Cotto - RAL8004	



Ειδικά τεμάχια

Σκαλοπάτια

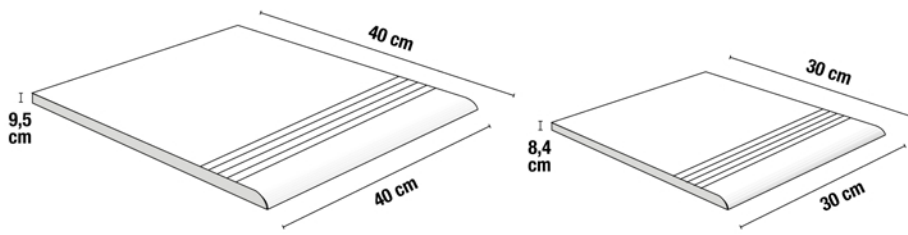

Κούρμπες υγιεινής

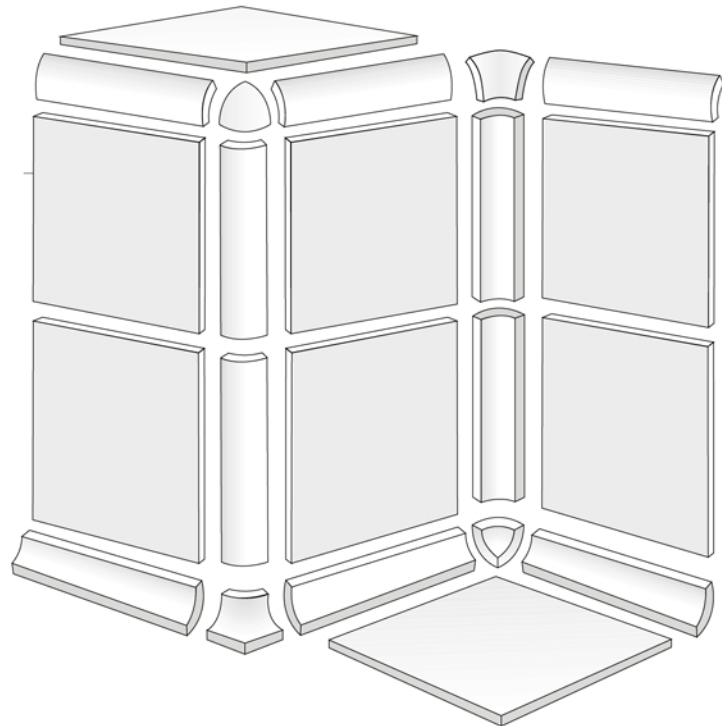
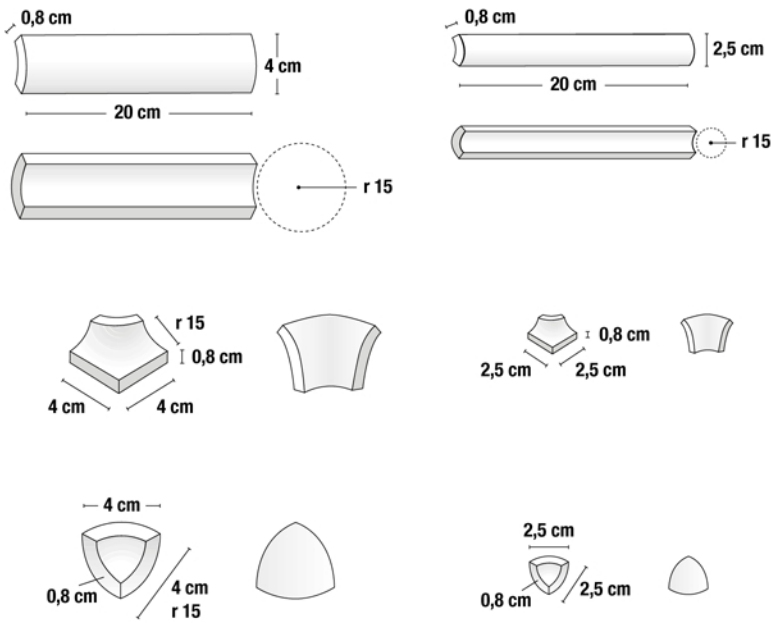

Σοβατεπί κούρμπα υγιεινής

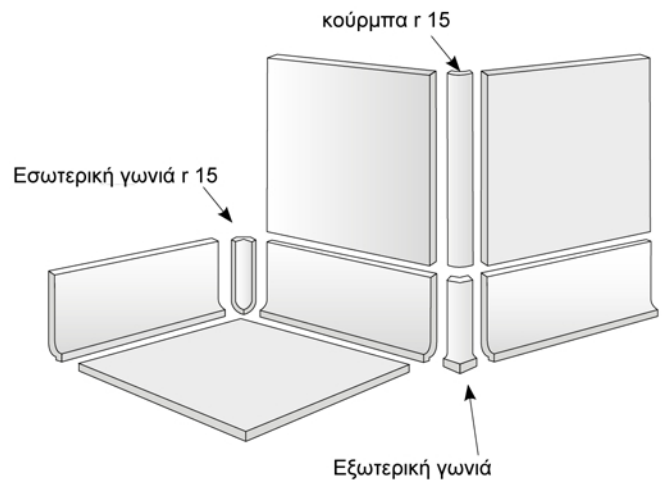
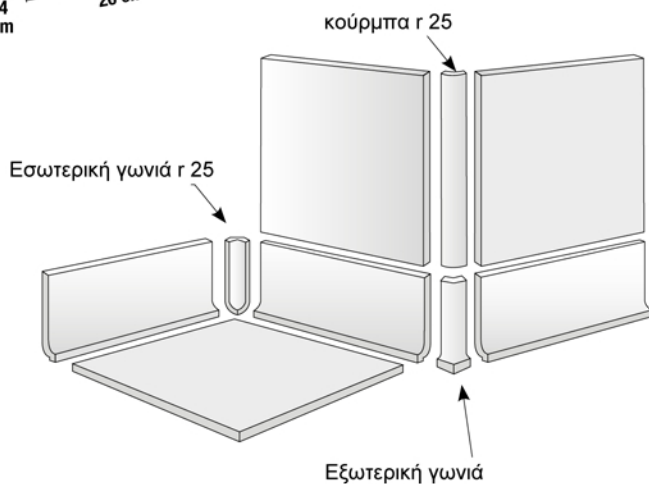
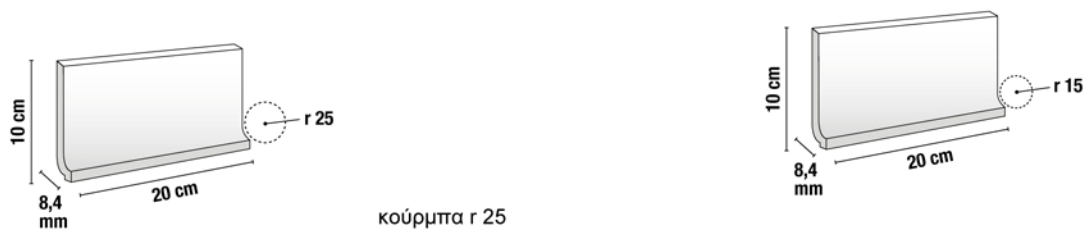

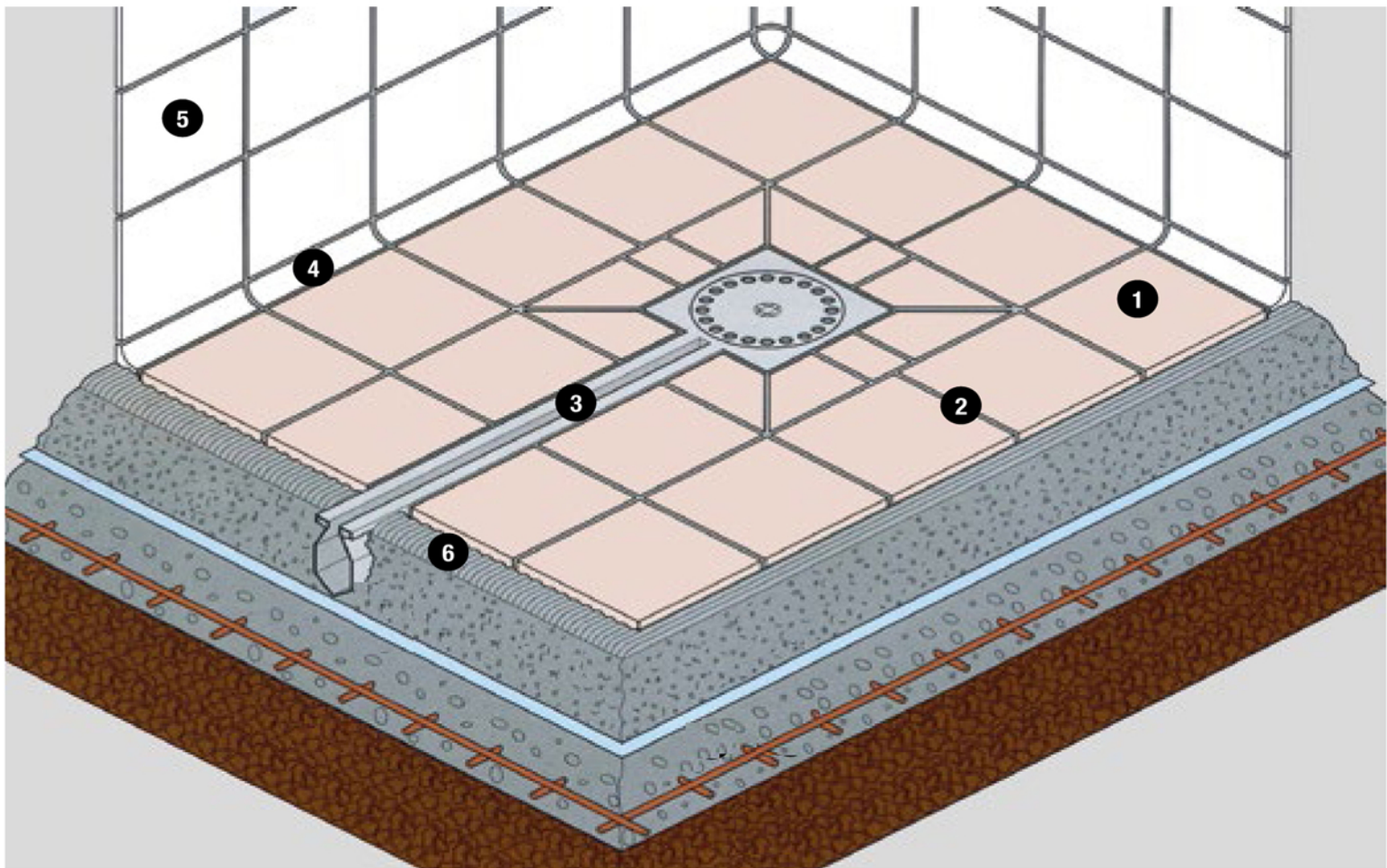

Δείγμα με κούρμπα υγιεινής και ανοξειδωτο κανάλι σχισμής

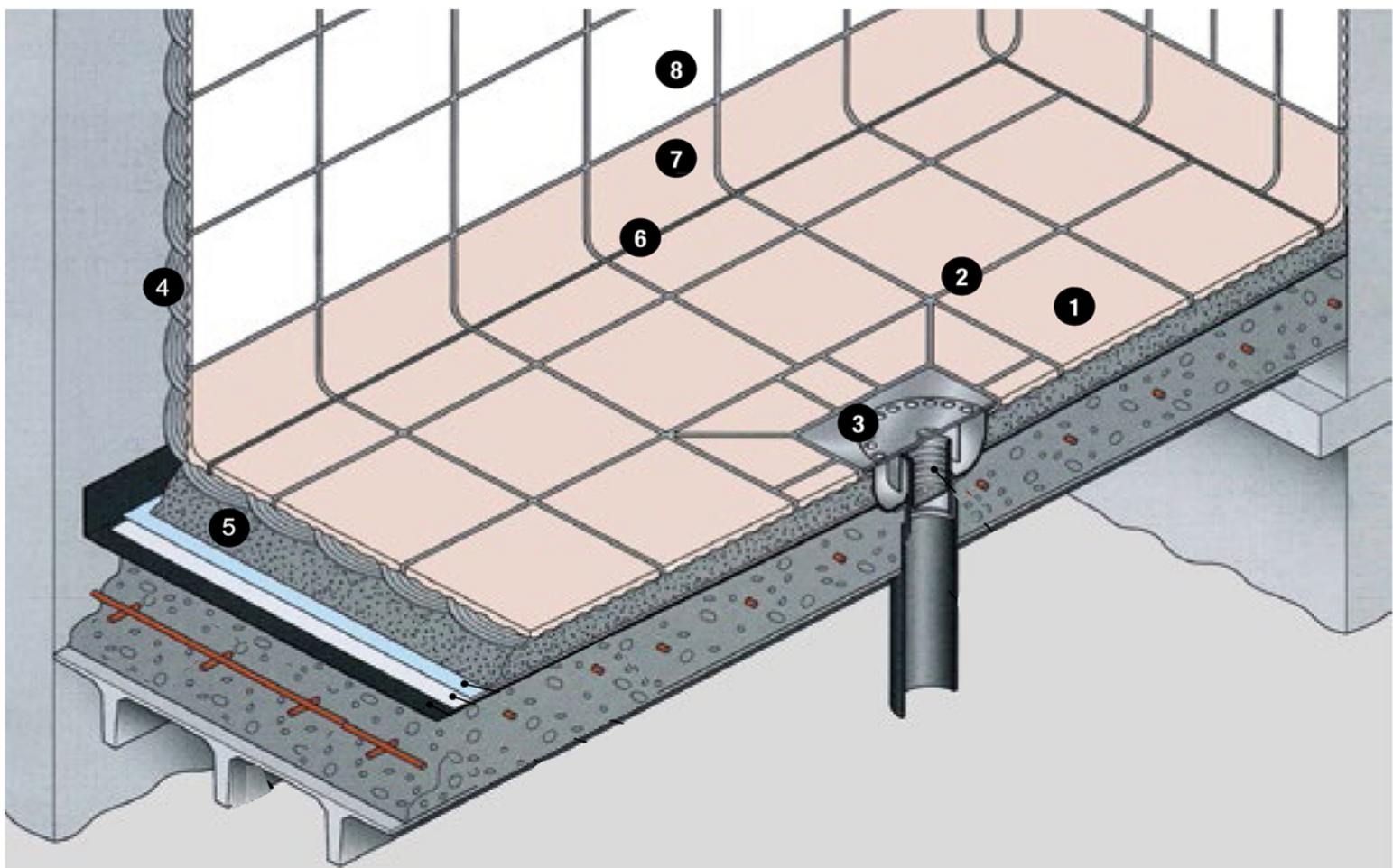

Δείγμα με σοβατεπί κούρμπα υγιεινής και ανοξειδωτο τετράγωνο σιφώνι

Πισίνες (περιβάλλοντες χώροι)



Εκθέσεις και συνεργεία αυτοκινήτων



Super markets και εμπορικά κέντρα



Δημόσια κτίρια και εξωτερικοί χώροι (γραφεία, σχολεία, πλατείες, σταθμοί μετρό κ.α.)



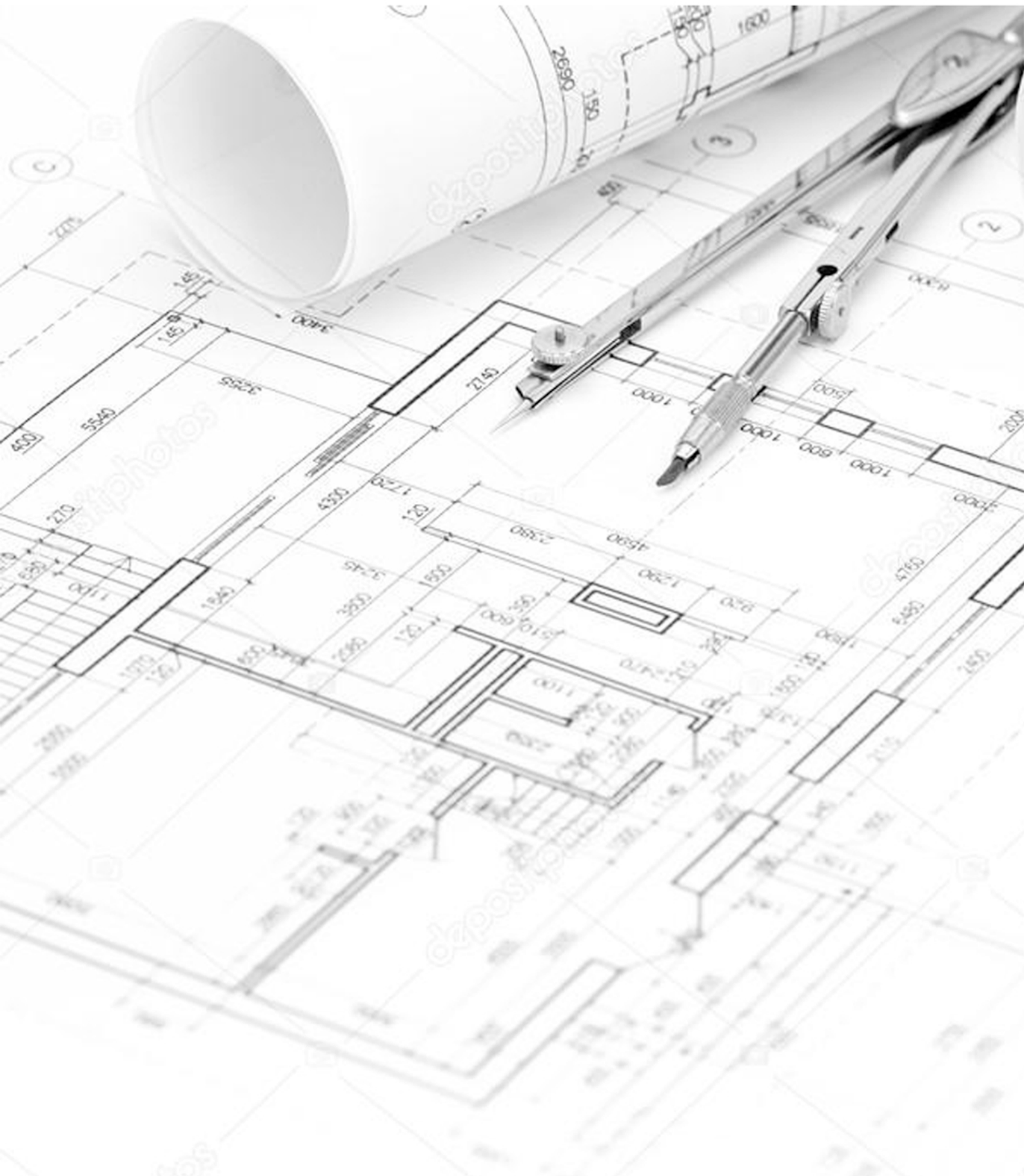

**ADVANCED
CONSTRUCTION
MATERIALS**

ΕΥΣΤ. ΚΟΚΚΙΝΟΣ & ΣΙΑ Ο.Ε

Λεωφ. Αλ. Παπαναστασίου 41 - 173 41 Αγ. Δημήτριος
T: 210 9754055 F: 210 9763709 E: info@acm.gr W: www.acm.gr